

# ROBOT LAWN MOWER

---

## USER MANUAL



Please read this manual carefully before use  
Please keep this manual for future reference

CE ROHS



## **CONTENTS**

<b>1. INTRODUCTION AND SAFETY</b>	<b>1</b>
<b>2. PRESENTATION</b>	<b>3</b>
<b>3. INSTALLATION</b>	<b>6</b>
<b>4. CONTROL PANEL AND REMOTE CONTROL</b>	<b>10</b>
<b>5. USE</b>	<b>11</b>
<b>6. MAINTENANCE AND STORAGE</b>	<b>15</b>
<b>7. TROUBLE SHOOTING</b>	<b>16</b>
<b>8. EXPLODED VIEW</b>	<b>18</b>

# 1. INTRODUCTION AND SAFETY

## 1. INTRODUCTION AND SAFETY

### 1.1 Introduction

The products are manufactured by Zhejiang Tianchen Intelligence & Technology Co., Ltd.  
www.tianchen-cn.com

Thank you for purchasing our product. You will have and enjoy the extra free time while using our robot lawn mower to mow your lawn. You will be impressed with your lawn's appearance and best of all, Tianchen robot did it for you.

The robot mower may be used only by those who know how to operate it after reading and understanding the instructions in this manual.

Model: S520

CE, RoHs approved.

Product, product specifications and this document are subject to change without notice. All other trademarks are property of their respective owners.

### IMPORTANT!

The following pages contain important safety and operating instructions. Please read and follow all instructions in this manual. Carefully read and review all safety instructions, warnings and cautions contained in this manual.

Failure to read and follow these instructions, warnings and cautions statements may result in severe injury or death to persons and pets or damage to personal property. It's not permitted to modify the original design of robot. All modifications are made at your own risk.



#### WARNING

Robot lawn mower can be dangerous if incorrectly used!

### IMPORTANT INFORMATION

Read through the Operators Manual carefully and understand the content before using your Robot.

### 1.2 Symbols on Mower

These symbols can be found in the mower. Study them carefully so you understand their significance.

1. The symbol is pasted on the top cover, Please read the means carefully before use the appliance.



1. WARNING-this is a dangerous power tool. Use care when operating and follow all safety instructions and warnings.

2. Read the owners/operating manual carefully and follow all safety instructions before operating the machine.

3. Objects can be thrown from mower while operating, keep a safe distance from the machine when operating, take caution.

4. Keep children, pets and bystanders away from mower when operating.

5. WARNING-Operate the disabling device before working on or lifting the machine.

6. Never use a high-pressure washer or even running water to clean the mower.

7. Sharp rotating blades. Keep hands and feet away and do not attempt to lift mower from this area.

8. WARNING-Do not ride on the machine.

### 2. Handle symbol.



Always lift the mower by Handle.



#### WARNING

Severe injury or death may cause if incorrectly lift the mower.

Carry the mower by the handle at the rear under the mower. Carry the mower with the blade device away from the body.

### 3. Specifications symbol

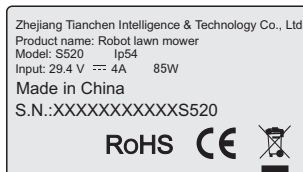

Pasted on mower

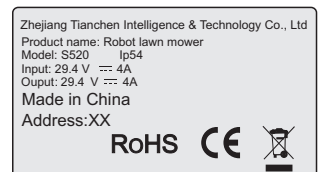

Pasted on charging station

ADDRESS: XX

Enter XX to mower, in order to match the communication between charging station and robot lawn mower.

S.N.: XXXX XX XX XXX  
year month date number

 : Waste electrical products should not be disposed of as household waste. Please recycle where facilities exist. Check with your Local Authority or retailer for recycling advice.

# 1. INTRODUCTION AND SAFETY

## 4. Charging station symbol.

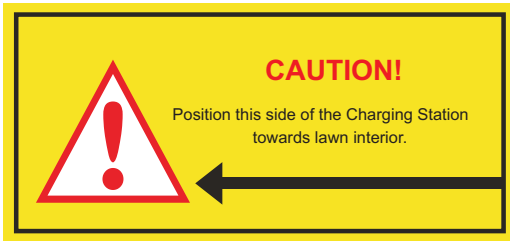

This label is pasted on charging station, please make sure to position this side towards lawn interior. Failure to do may result in damage to property or persons.

## 5. Warning symbol.

DANGER! Sharp rotating blade. Keep hands and feet away. Serious injury can occur.



## 1.3 Symbols in the User Manual

These symbols can be found in this user manual.



A warning box indicates a risk of personal injury exist.



An information box indicates a risk of material damage exist, especially when the stated instructions are not followed. The box is also used where there is a risk of user error.

## 1.4 Safety instructions

- Read the owners/operation manual carefully and follow all the safety and warning instructions.
- This machine has sharp rotation blades! Never allow the mower to operate unattended; keep bystanders, children and pets away from mower when in operation.
- Never allow anyone to ride or sit on mower.
- Never allow anyone or person who is not familiar with the safe operation of the mower to operate the mower.
- Keep hands and feet away from the cutting blades and other moving parts.
- Never attempt to service or adjust the mower while it is in operation.

- Inspect and clear the mowing area of all debris (toys, tree branches, items of clothing, anything with a height less than 6cm) before operating the mower.
- Never raise the mower or attempt to inspect the blades while the mower is operating.
- Always turn off the power before lifting the mower or attempting any adjustment.
- When operating the mower in manual mode, maintain a safe distance from behind or around the mower and wear proper foot apparel.
- Do not operate the mower on slopes greater than 30 degrees or use it in manual operation on slopes where a firm footing is not possible.
- Do not operate the mower if any safety feature or device is damaged or inoperable.
- Do not attempt to disable or defeat any safety feature or device.
- Use heavy gloves when inspecting or servicing the blades.
- Wear eye protection and use gloves when installing the virtual wire and driving the wire stakes/pegs. Firmly drive all pegs in order to keep the wire from becoming a tripping hazard.
- Do not use the charging station power supply with an extension cord.
- Use only the original equipment power pack and power supply/charger with this mower.
- Do not use the power supply/charger if the cord has become damaged.
- Do not place metal objects in the area of the charging sheets on the charging station.
- Do not place metal objects across the charging heads of the mower.
- Do no spray water directly into the docking area of the charging station or onto the control panel on charging station.
- The mower has sharp rotating blades! Please care the mower when it is mowing, in case of serious injury occur.
- Keep the lawn mower in perfect operating conditions by performing the maintenance procedures outlined by the manufacturer. Good maintenance guarantees better performance and longer service life.
- In order not to irreversibly damage electric and electronic parts, do not wash the robot with water jets at a high pressure and do not plunge it partially or thoroughly in water, as it is not watertight.
- It is absolutely forbidden to use the robot in explosive and flammable environments.
- The operator or user is responsible for accidents or hazards occurring to other people or their property.
- Fill up all small holes and even all small mounds inside working area. It's to keep the robot with perfect operating.

## 2. PRESENTATION

### 2. PRESENTATION

This chapter contains information you should be aware of before placing the installation.

#### 2.1 What's in box



- ① Clamshell:  
Open it to adjust cutting height or turn on the power button.
- ② Adjusting knob:  
Rotate the adjusting knob to adjust the cutting height from 2.5-6cm.
- ③ Power button
- ④ USB connector
- ⑤ Charging sheet
- ⑥ Rain sensors
- ⑦ Emergency switch on control panel:  
Press it to turn off the mower.
- ⑧ Handle (Touch sensor)  
Touch it when it's working,  
Mower stops at once.
- ⑨ Blade
- ⑩ Blade shield
- ⑪ Home button  
Press it when the mower is on,  
it goes back to charging station automatically.
- ⑫ Charging light  
Red: charging  
Green: full charged / idle.
- ⑬ Virtual wire light  
Colorless: in good connecting  
Red: Broken wire/ idle
- ⑭ Power terminal
- ⑮ Virtual wire terminal  
red terminal(+)  
black terminal(-)
- ⑯ Charging head
- ⑰ Hole for stake
- ⑱ Charger
- ⑲ Virtual wire (100m):  
Used to mark mowing area and  
create a virtual wall for the mower.
- ⑳ Virtual wire connectors (10pcs):  
Used to connect virtual wire.
- ㉑ Pegs (100pcs):  
Used to fix the virtual wire to the  
ground around the lawn perimeter  
and around obstacles.
- ㉒ Stakes (4pcs):  
Used to fix the charging station to  
the ground.
- ㉓ Remote control (1pc)
- ㉔ Remote control battery (2pcs)
- ㉕ Blades for replacement (4pcs)
- ㉖ Inner hexagon spanner (1pc)
- ㉗ English user manual

#### Consumable parts:

1. Blades
2. Virtual wire
3. Virtual wire connectors
4. Pegs
5. Stakes
6. Remote control battery
7. Inner hexagon spanner
8. Rear running wheels
9. Front wheels

## 2. PRESENTATION

### 2.2 Function of S520

#### - Lift sensor

There are lift sensors located between the top and middle cover. If the mower is lifted from ground, it will stop working within 1 second.

#### - Tilt sensor

There are tilt sensors installed on the mower too, when the mower is tilted over 30 degrees in any direction, it stops working within 2 seconds.

#### - Bump sensors

The whole top cover is movable. Both front and the two sides of mower equipped with bump sensors that will activate when the mower strikes solid, fixed object when that object is at least 6cm in vertical height from the supporting surface of the mower. When the bump sensor activated, the mower will stop movement in that direction and reverse itself away from the obstacle.

#### - Rain sensors

There are two rain sensors located on the control panel at top cover of mower. The mower will go back to the charging station automatically when it's raining. Rain sensors can be selected ON/OFF from control panel. Turn on: the mower will go back home if it is raining. Turn off: the mower will go on mowing when it is raining.

#### - Touch sensor

Touch the handle when the mower is cutting, it will cease function within 0.5 second.

#### - Wireless remote controller

#### - Mowing schedule

Set up one week (From Monday to Sunday, once for each day) cutting schedule from control panel. This function should be used together with AREA function.

#### - Anti-theft function

Mower has password protection option to guard against theft. What's more, the mower can not be turned on without a charging station.

#### - Cutting width: 28cm

#### - Easy cutting height adjustments

2.5cm-6cm selected with one dial.

#### - Auto recharge system

When the mower senses a low battery situation, it will shut off the cutting motor and search for the virtual wire. Once found it will follow the virtual wire to the charging station for recharge automatically. Once charging is complete, the mower will back up a few centimeters ready to go again in stand by mode.

#### - Emergency stop switch

There is an emergency switch located on the top of mower and red in color. When pressed, the mower will shut down immediately. Rotate the switch clockwise to release it.

#### - Two cutting modes

There are two cutting modes of the mower, go straight and go circle (high efficiency). In Auto, mower selects cutting mode intelligently. It goes straight if the grass is sparse or it has been cut off, and it goes circle if the grass is dense or long. In manual mode, the mower will just go where you direct it.

#### - Pressure sensors

The pressure sensors located on the top cover. If a child or some thing rides or sits on the mower, it stops working within 1 second.

#### - Virtual wire

The robot lawn mower can't be operated without a virtual wire. (we suggest to use 100m-600m of virtual wire). The mower will follow virtual wire to charging station, the virtual wire acts as a virtual fence. It will get on the virtual wire until it meets charging sheets, then it gets off from virtual wire and starts cutting inside.

LINE (virtual wire) can be selected ON/OFF from control panel.

#### - Mower stops working if virtual wire is cut off or charging station is power off.

If virtual wire is cut or broken, or the charging station loose power, the mower will stop working within 3 seconds

#### - Four steps to safely start the mower

There are four necessary steps to start the mower:

1. Connect charging station with power supply by charger and make sure the recharging light is in green color.
2. Connect virtual wire to charging station and make sure it is in good connecting (virtual wire light in colorless).
3. Turn on the power button and release the emergency switch.
4. Input password if selected and select mode.

#### - Overload protect

The brushless cutting motor and each of the two running motors are monitored continuously during operation for any situation that may cause these motors to over-load. In the event this is detected, the mower stops operating.

#### - Waterproof

Waterproof design, there is an inner cover under top cover which protect inside parts from humidity. The waterproof class is IP54.

#### - LCD display

#### - Electronic compass

The mower has compass navigation system to keep it going straight on inclines.

#### - Subarea setting

You can select Subareas for the mower to cut. This works well for large lawn. See Section 5.12. This function should be used together with **schedule**.

#### - Different languages selection.

#### - Range

There are four range options, user can choose the distance when robot hit virtual wire according the condition of different lawns.

## 2. PRESENTATION

### 2.3 Technical date

<b>Model No.</b>	<b>S520</b>	<b>Battery</b>	
<b>Mower technical date</b>		Type of battery	Lithium
Gross weight	21KGS	Battery capacity	6.6Ah
Net weight	18KGS	Charging time	≤3hours
Mower size	60.5*46.5*28cm(LWH)	Average working time	2-3hours
Rated power	85W	<b>Functions:</b>	
Noise	≤60db	Follow virtual wire walking is optional	✓
Qty for cutting blades	4pcs	Mower is disabled without power to charging station	✓
Cutting height	2.5-6cm	Mower is disabled if virtual wire is cut or broken	✓
Cutting width	28cm	Pressure sensor	✓
Cutting speed	35m/min	Rain sensor	✓
Blades rotate speed	3000rpm	Auto recharge	✓
Hill capability	30degree Max slope	Intelligent spiraling	✓
Max ambient functioning temp.	40℃	Go straight	✓
Coverage(for once charging)	800m <sup>2</sup> ±20%	Anti theft	✓
Working capacity	2600m <sup>2</sup> ±20%	Lift sensor	✓
<p>Note: How large an area is mow per recharged depends primarily on the condition of the blade and the type of grass, growth rate and humidity. The shape of garden is also significant. If the garden mainly consists of open lawns, mower can mow more area per hour than if the garden consists of several small lawns separated by trees, flower beds and passages.</p>		Tilt sensor	✓
		Ultrasonic sensor	x
		Bump sensor	✓
		LCD display	✓
		Waterproof	✓
		Touch sensor	✓
		Time set-up system	✓
<b>Charging station and virtual wire</b>		Emergency switch	✓
Charging station size	78*50*20cm(LWH)	Password set-up	✓
Virtual wire maximum length	600m/0.5mm	Electronic compass	✓
Standard virtual wire length	100m/0.5mm	Language option	✓
Wireless remote control distance	6M	Subarea setting	✓
		Range option	✓

### 2.4 Working route





## 3. INSTALLATION

### 3. INSTALLATION

This chapter describes how you to install this mower. Before starting the installation, read the previous chapter 2. Presentation.

Read the whole of this chapter before starting the installation. How the installation is made also affects how well the mower will work. It is therefore important to plan the installation carefully.

#### 3.1 Preparations

Training

- Read the instructions carefully. Be familiar with the controls and the proper use of the mower.
- Never allow people unfamiliar with these instructions or children to use the mower. Local regulations may restrict the age of the operator.
- The operator or user is responsible for accidents or hazards occurring to other people or their property.

#### 3.2 Hardware adjustments

##### Blade adjustment

The mowing system used by this mower is based on an effective and energy efficient principle. Unlike normal lawn mowers, the mower cuts the grass instead of striking it off.

Rain sensors on the mower is optional (See P13-5.8 RAIN), we recommend you allowing the mower to mainly mow in dry weather to obtain the best possible result. Even though the mower can mow in rain, wet grass easily collects on the mower and the risk of slipping on steep slopes is greater.

The blades must be in good condition to obtain the best mowing result. In order to keep the blade sharp for as long as possible it is important to keep the lawn free from branches, small stones and other objects (especially the objects less than 6cm height). Please fill up small holes and even out small mounds to make sure lawn is flat.

##### How to adjust the cutting height:

1. Press the clamshell and open it.
2. Rotate the adjusting knob to adjust the cutting height. Cutting height from 2.5cm to 6cm.

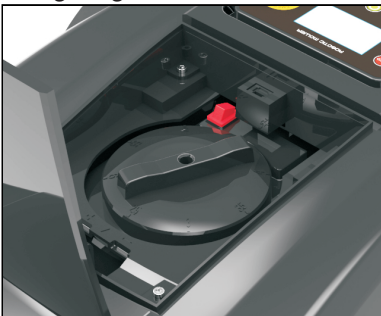

Adjusting knob

3. Closed the clamshell.

Cutting height explanation: take 3cm level for example.

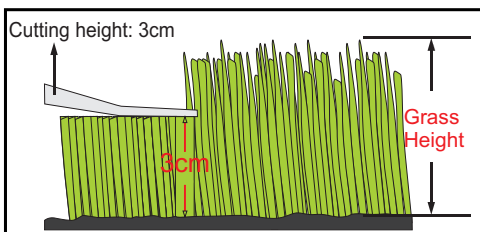

### 3.3 Charging station installation

- Choose best installation place, please make sure it is flat, no water, no magnetic interference and no obstacle in the front of charging station.

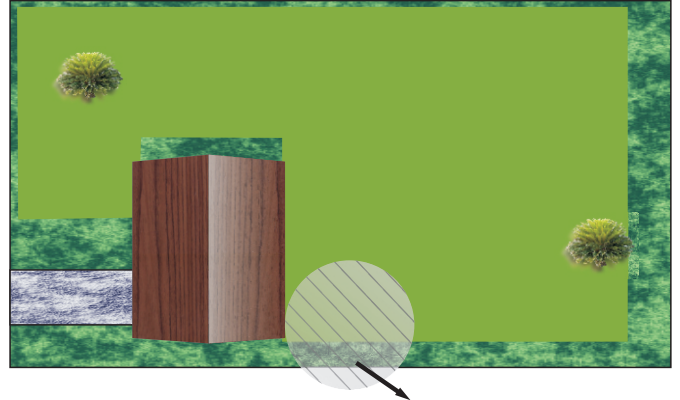

- Charging station best install place:
1. Make sure it is flat
  2. No magnetic interference
  3. No water and far away from puddle
  4. No obstacle in front of charging station

- Please fix the charging station on horizontal place.

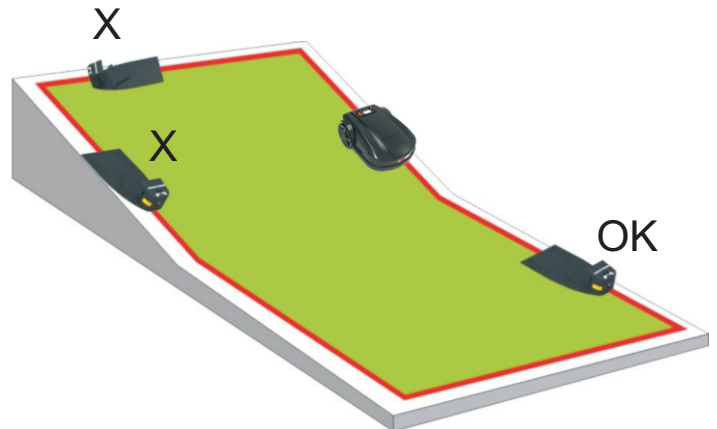

- Lay virtual wire as picture shows.

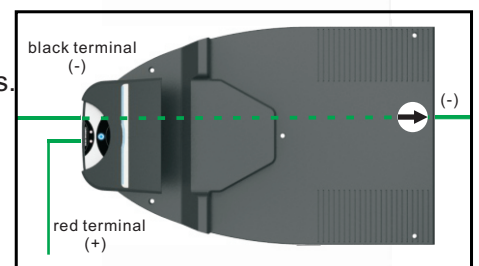

- Fix the charging station with four stakes by hammer.

#### IMPORTANT INFORMATION

Before fix the charging station on the lawn, please examine the lawn and decide the best location where is easy for the mower to find the station for recharge.

#### IMPORTANT INFORMATION

Do not tread or walk on the charging station plate.

### 3. INSTALLATION

#### 3.4 Virtual wire installation

The virtual wire can be installed in one of the following ways:

**- Securing the wire to the ground with pegs.**

It is preferable to staple down the virtual wire, if you want to make adjustments to the virtual wire during the first few weeks of operation.

**- Bury the wire**

It is preferable to bury the virtual wire(max depth: 5cm) if you want to detach or aerate the lawn.

If necessary both methods can be combined so one part of the virtual wire is stapled down and the remainder is buried.

**- Install virtual wire with pegs 1 meter apart. It's best to use smooth radius corners than sharp angles. See pictures.**

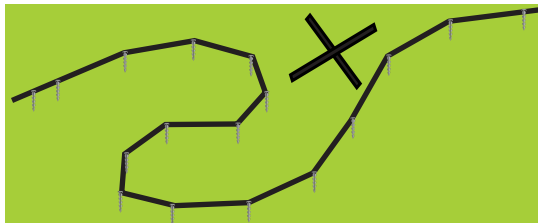

**- Bury virtual wire below grass and fasten it on the ground with pegs, so that the mower should not cut the wire.**

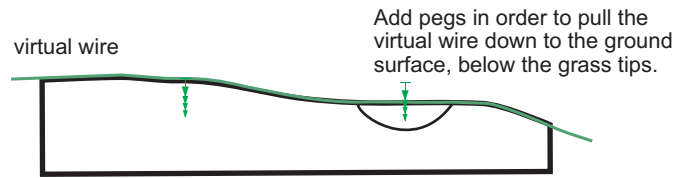

**IMPORTANT INFORMATION**

Hard or dry ground may cause pegs to break when driving them in. In extreme cases, watering the lawn where the pegs will be driven.

- A minimum distances between the front of the charging station and an obstacle is 2 meters. And make sure the distance from corner to front of charging station is at least 2.5 meters. Make sure to lay a 2.5 meters minimum straight-light of virtual wire in front of charging station.

- If a high obstacle, for example a house, wall, fence or other obstacle which is higher than the cutting lawn borders the working area, the virtual wire should be laid at least 40cm from the obstacle. This will prevent mower from colliding with the obstacle.

- If a passage or a ground with same height of cutting lawn, the virtual wire should be laid at least 10cm from the edge.

- A minimum distance between the pool edge of virtual wire is 40cm.

- A minimum distance between two corners is 1meter.

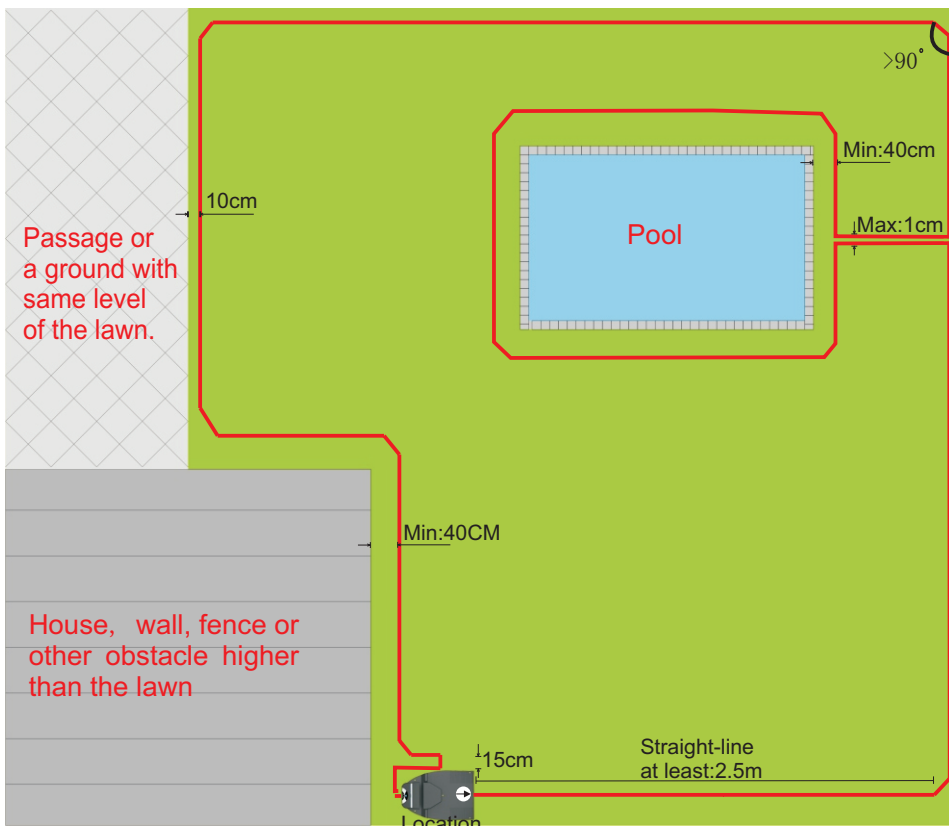

- A maximum distance of the virtual wire to and from the island is 1cm, and fix the two wires with one peg.

- There are two types of set up of the virtual wire around the charging station.

Put the charging station near corner. please take location for reference.

Please make sure to set a straight-line at least of 2.5m in front of charging station. The charging station should be far away from puddle.

### 3. INSTALLATION

- Use the virtual wire to isolate areas inside the working area by creating islands around obstacles that can not withstand a collision, for example, flower beds and fountains. Run the wire out to the area, route it around the area to be isolated and then back along the same route. If pegs are used, the wire should be laid under the same peg on the return route. When the virtual wire to and from the island with a maximum distance of 1cm, the mower can drive over the wire.

- If protected obstacles are grouped closely together isolate them individually. Continuous virtual island if obstacles are close to edge, leave them out of the mowing area.

- A maximum distance between the wire and tree root is 20cm.

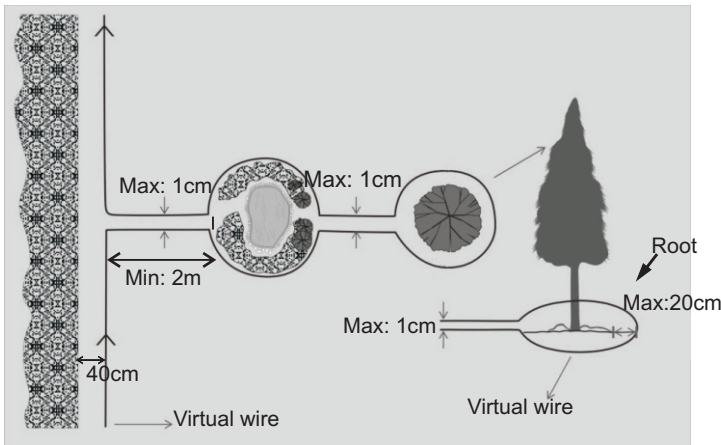

- Care must be taken not to create a corner sharper than 90 degrees when setting up virtual wire. A corner sharper than 90 degrees can cause the mower to lose track of virtual wire. We can make greater than 90 degrees corner like follow picture shows.

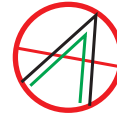

Incorrect corner setup

Correct corner set up, using several angle to avoid an angle of less than 90° .

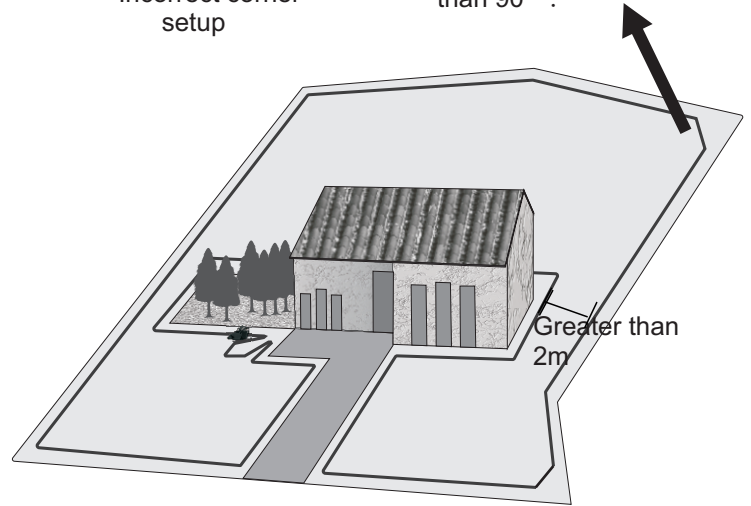

Proper setup in sharp corners

- The distance between charging station and virtual loop should be 2 meters at least.

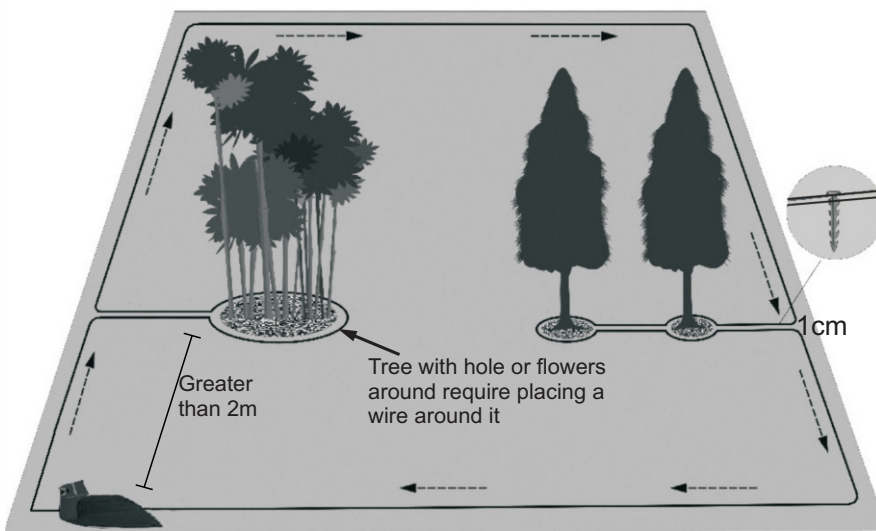

#### Virtual wire connecting

- Joining the virtual wire .  
If the virtual wire is not long enough and needs to be spliced: Use supplied wire connector. It is waterproof and gives a reliable electrical connection.

To splice: Insert both cable ends in the connector. Now press down the button on top of the connector fully. Use a pair of pliers or the like, as the button on the connector is difficult to press down by hand.

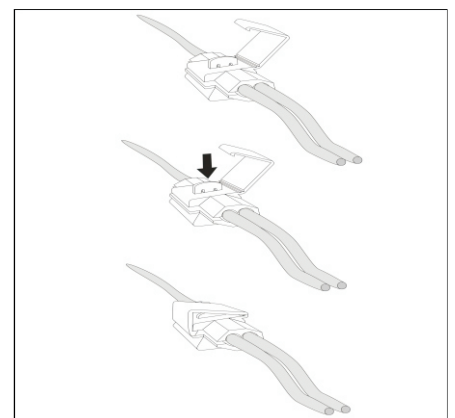

### 3. INSTALLATION

#### 3.5 Charging head installation.

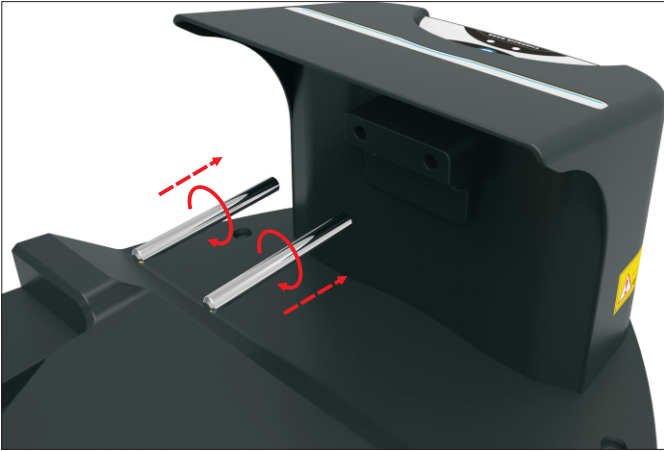

Please fasten the charging heads on the charging station in clockwise.

#### 3.6 Virtual wire and charging station connecting.

1. Cut the two ends of virtual wire to a length of 1cm that's convenient for reaching the virtual wire terminal on charging station. Strip the two ends of wire.

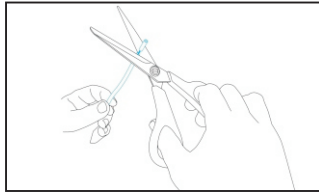

2. Connect the cut two ends of virtual wire to virtual wire terminal located on charging station. Pls take care of positive and negative terminal.



3. The virtual wire light turns colorless while virtual wire connected well with charging station. A failed connecting between virtual wire and charging station cause a blinking red light and send out a beeping from charging station.



#### WARNING

Redundant virtual wire at back of charging station must be cut off.

#### 3.7 Power connection.

1. Connect charger terminal **b** with charging station power terminal **a**.

Connect 1 from plug a to 1 from plug b and screw it tightly.

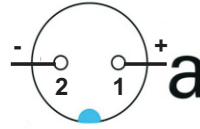

Power terminal on charging station

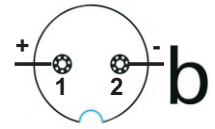

Power terminal on charger

2. Connect the charger with power supply.
3. Charging light on station in green: Non-recharging. charging light on station in red: recharging.

#### 3.8 Recharge.

1. Recharge Voltage: 24V  
Recharge current: 4A

2. When the display shows picture to the right, the robot is going to find virtual wire and follow it back to station for recharge.



3. The display is showing picture to the right, it's in recharging.



4. 

The display is showing picture to the right, it's in recharging. rain sensors are activated



#### IMPORTANT INFORMATION

All the buttons (except the emergency switch and power button ) are locked which can not be used during the robot is in recharging.

4. The mower reverses several centimeters and stop there with entering standby mode after fully recharged.

## 4. CONTROL PANEL AND REMOTE CONTROL

### 4. CONTROL PANEL AND REMOTE CONTROL

#### 4.1 Control Panel view

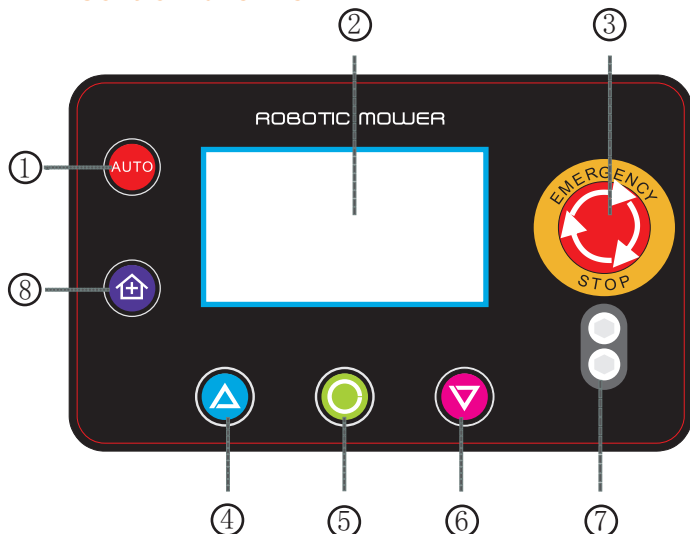

① Auto mode

② Display

- A. Charging station symbol
- B. Working schedule symbol
- C. Rain sensor symbol
- D. Compass
- E. Line symbol
- G. Pressure sensor
- H. Touch sensor
- I. Auto mode
- J. Battery voltage
- K. Month / Date
- L. Week
- M. Hour / Minute

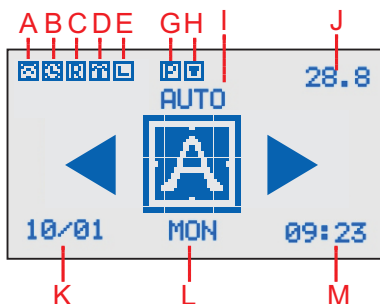

③ Emergency switch

④ Up / + :

- select menu, go upward
- select menu, go left
- Select figure, means +

⑤ Enter button

- To confirm your selection or enter it.

⑥ Down / -

- select menu, go down
- select menu, go right
- Select figure, means -

⑦ Rain sensors

⑧ Home button

- Press this button when the mower is operating, it goes home for recharge automatically.

#### 4.2 Remote control

① Indicator light.

② ON/OFF button: To stop the mower. Press it, the mower enters standby mode.

③ Speed up.

④ Turn right.

⑤ Speed down.

⑥ Enter MANUAL pattern

⑦ Turn on or turn off the cutting blade.

⑧ Turn left.

⑨ Enter AUTO pattern

⑩ Press it when the mower is on standby mode or working, it goes back to charging station.

⑪ Battery location, with 2pcs AAA battery

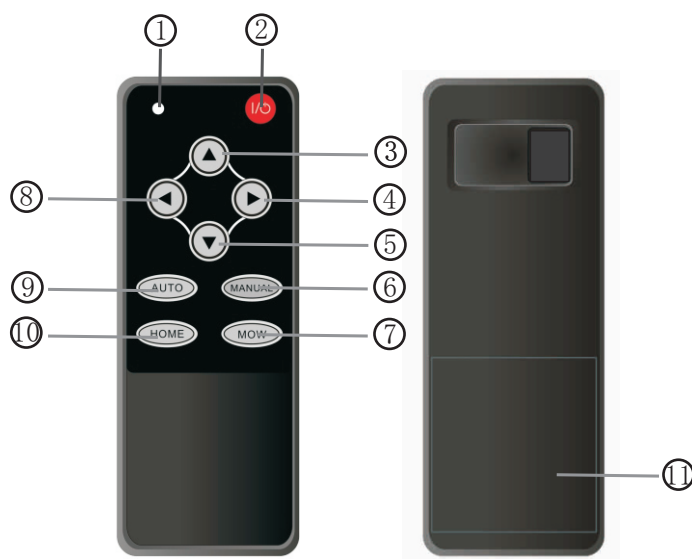

#### IMPORTANT INFORMATION

Remove the 2 batteries from remote control while it is in idle for a long time.

**Remote control can only be used when it has a same frequency with mower. (The remote control was matched with mower before leave the factory).**

How to match the remote control with mower:

1. Turn on the charging station.
2. Take the remote control near charging station.
3. Press ON/OFF button on remote control until the indicator light is blinking. Then release the ON/OFF button.
4. It finishes matching with the mower while the indicator light stop blinking.

## 5. USE

### 5. USE

#### IMPORTANT INFORMATION

- Do not leave the mower to operate unattended if you know that there are pets, children or people in the vicinity
- Mow only in daylight or in good artificial light.
- Avoid operating the mower in wet grass.
- Do not operate the mower when barefoot or wearing open sandals.
- Always wear substantial footwear and long trousers.
- Always be sure of your footing on slopes.
- Use extreme caution when reversing the mower towards you.
- Always switch on the mower according to instructions with feet well away from the blade.



#### WARNING

Read the safety instructions before you start your mower.



#### WARNING

Keep your hands and feet away from the rotating blade. Never put your hands or feet close to or under the body when the motors are running.

#### 5.1 Preparation

- Ensure the correct installation of the virtual wire.
- Periodically inspect the area where the mower is to be used and remove all stones, sticks, wires, bones, and other foreign objects especially the height of objects is less than 6cm.
- Periodically visually inspect that the blades, blade bolts and cutter assembly are not worn or damaged. Replace worn or damaged blades and bolts in sets to preserve balance.
- Connect the two ends of virtual wire to the terminal on charging station, and ensure virtual wire is in good connecting. (Light on charging station is in colorless).
- Insert charger into charging station and secure it with threaded cap. And then connect charger to power supply. Ensure the charging station has a good connection and the light on charging station is Green.
- Periodically inspect the lawn is without any small hole or mound.

#### IMPORTANT INFORMATION

User can not start the mower if virtual wire or charging station is not in good connecting.

#### 5.2 Starting the mower

There are two locations of start the mower.

1. Take the mower clockwise onto virtual wire, make sure that the mower is not connected with two charging sheets on charging station. Otherwise, the mower is in recharging Mode, it can not be started.
2. Take the robot to start point.



To set **LINE** off, the robot begins cutting inside lawn directly.

To set **LINE** on, the robot will follow the virtual wire cutting for one circle, and finish cutting on the virtual wire first.

#### IMPORTANT INFORMATION

It's a normal phenomenon that the mower goes a circle to calibrate direction while it is working inside of signed lawn. If it meets obstacle or detects virtual wire before it finishes a circle, it will go on to make a new circle in new place.

#### To start the robot.

1. Turn on the Power button under the clamshell.
2. Clockwise rotate the Emergency switch  on control panel to turn on the robot.
3. Input Password (Initial password:0000), the robot enters on standby mode.
4. Select AUTO  mode, the mower start working.

#### 5.3 Stopping mower /Turning off mower

1. Press power button from remote control. Mower stops and enters standby mode.
2. The mower also can be powered off by press the Emergency switch  directly.
3. Press power button under clamshell to power off the the mower.

#### 5.4 Emergency Switch

Press Emergency switch  at any time the mower power off at once. User has to restart it.

## 5. USE

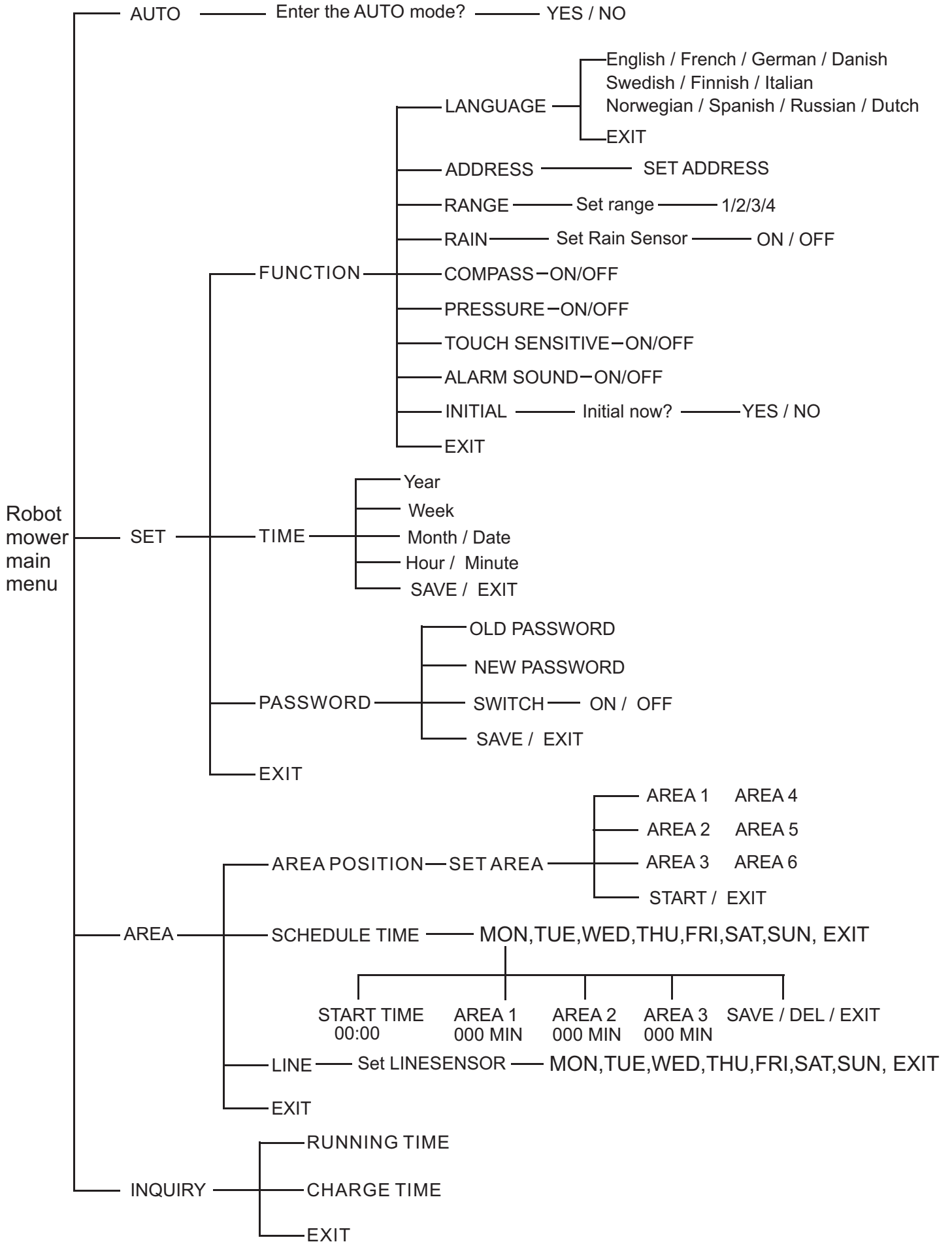

## 5. USE





### 5.5 Language selection

1. Select **SET**  and enter it by pressing key .
2. Select **FUNCTION** and enter it by pressing key .
3. Select **LANGUAGE** and enter it by pressing key .
4. Select English / French / German / Danish / Swedish / Finnish / Norwegian / Italian / Spanish / Russian / Dutch and confirm the selection by pressing key .





### 5.6 Address setting

There is an **ADDRESS** between robot and charging station. Factory already set address in advance, user does not need to set the address before using it. **A label** with Address Code pasted on charging station.

#### To reset the address:

1. Select **SET**  and enter it by pressing key .
2. Select **FUNCTION** and enter it by pressing key .
3. Select **ADDRESS** and enter it by pressing key .
4. Input the Address Code 00-59.
5. Take mower near charging station, press button on station until the indicator light blinks, then release button.
6. It finishes matching until indicator light stop blinking.
7. Restart mower, it will have the charging station symbol .





### 5.7 Range setting

1. Select **SET**  and enter it by pressing key .
2. Select **FUNCTION** and enter it by pressing key .
3. Select **RANGE** and enter it by pressing key .
4. Select **1/2/3/4** and confirm the selection by pressing key .

### 5.8 Rain





**RAIN ON:** mower goes back to charging station when it is raining.

**RAIN OFF:** mower goes on working when it is raining.



1. Select **SET**  and enter it by pressing key .
2. Select **FUNCTION** and enter it by pressing key .
3. Select **RAIN** and enter it by pressing key .
4. Select **ON / OFF** and confirm the selection by pressing key .

### 5.9 Initial setting

Restore to factory settings.





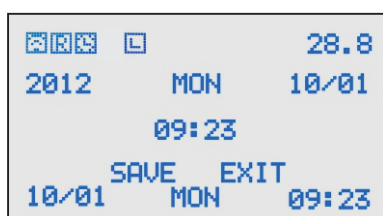

1. Select **SET**  and enter it by pressing key .
2. Select **FUNCTION** and enter it by pressing key .
3. Select **INITIAL** and enter it by pressing key .
4. Select **YES / NO** and confirm the selection by pressing key .

### 5.10 System time setting



1. Select **SET**  and enter it by pressing key .
2. Select **TIME** and enter it by pressing key .





3. To set Year.

- Press key  or key  to scroll to Year setting. press key .
- Press key  or key  to scroll to the correct Year. and confirm the setting by pressing key .

4. Set Week, Month/Date, Hour/Minute as Step 3.

5. Press key  or key  to scroll to SAVE and save the setting by pressing key .



### 5.11 Password setting

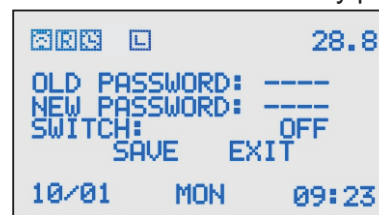

1. Select **SET**  and enter it by pressing key .
2. Select **PASSWORD** and enter it by pressing key .





3. Initial password: 0000

4. To input OLD PASSWORD.

- Press key  or key  to scroll to OLD PASSWORD press key .

- Press key  or key  to scroll to the correct password. and confirm the setting by pressing key .

5. To set NEW PASSWORD as Step 4.

6. Press key  or key  to scroll to SAVE and save the setting by pressing key .



#### Password function is optional.

**SWITCH ON:** every time the robot starts, user has to input correct password.

**SWITCH OFF:** user does not need to enter password when starts the mower.

### 5.12 Area setting



**This function is to increase the efficiency of the mower in a large area. It allows you to separate a larger area into 6 small areas. The function should be used together with P14-5.13 SCHEDULE SETTING, take separate 3 areas for example below.**

1. Select **AREA**  and enter it by pressing key .
2. Select **AREA POSITION** and enter it by pressing key .



3. To select the working area.

- AREA 1 is non-optional, selects this by default.

- Press key  or key  to scroll to AREA 2 and press key  to select AREA 2 works. "\*" comes in front of AREA 2.



## 5. USE

### IMPORTANT INFORMATION

If user does not select working in AREA 2, he can not set the robot working in AREA 3.

- Press key or key to scroll to AREA 3 and press key to select working in AREA 3. "\*" comes in front of AREA3.
4. To set the Memory Point.

**A Memory point** is to program the mower to leave the virtual wire. Each area should with a Memory point, 6 Memory points maximum in one mower.

**Please keep the voltage of mower more than 27V before setting the memory points.**

- Put mower onto virtual wire with a maximum distance of 1meter from charging station, and put the backside of mower towards to charging station.
- Select **START** and confirm it by pressing key . Then the robot starts follow virtual wire walking.
- Press key to set Memory point in AREA 1 when mower arrives at Memory 1.
- Press key to set Memory point in AREA 2 when mower arrives at Memory 2.
- Press key to set Memory point in AREA 3 when mower arrives at Memory 3.

Take Memory 1, Memory 2, Memory 3 as below picture for example.

- It's best to set the Memory point in the middle of two corners.
- A better position of Memory point is a 3 meters length of virtual wire at the beginning or the end of an area.
- Route the wire around the passage to separate the area. The virtual wire to and from the edge of passage is 1meter at least. check the setting as below picture.
- A minimum distance between the to and from virtual wire which are to make a passage from one area to another one is 50cm.

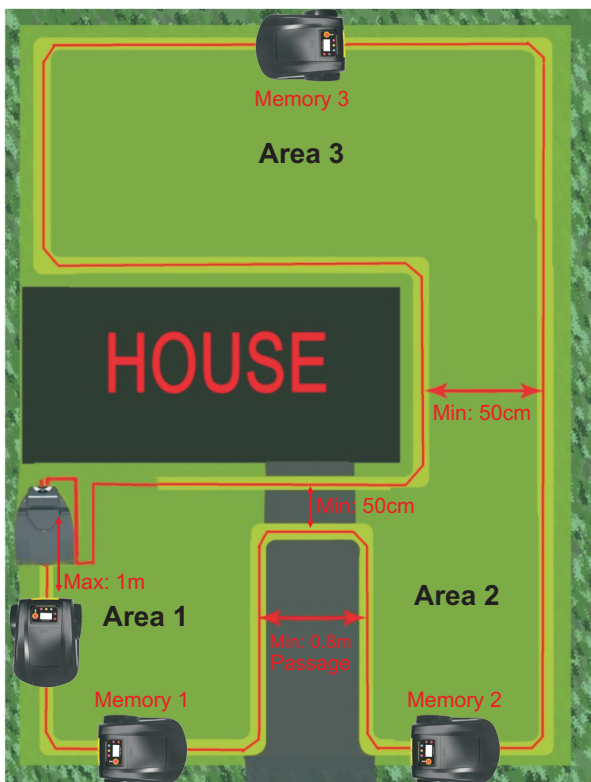

- Put the robot back to charging station and wait for working.

### 5.13 Schedule time setting

The schedule time setting should be used together with AREA function. **P13-5.12 AREA setting.**

1. Select **AREA** and enter it by pressing key .
2. Select **SCHEDULE TIME** and enter it by pressing key .
3. Select **WEEK** (MON,TUE,WED,THU,FRI,SAT,SUN) and enter it by pressing key .
4. To set START TIME.
  - Select **START TIME** and enter it by pressing key .
  - Press key or key to set Hour/ Minute. and confirm the settings by pressing key .
5. To set working time in each area.
  - Select **AREA 1** and enter it by pressing key .
  - Press key or key to set how long should the robot works in AREA 1, and confirm the settings by pressing key . 10minutes for each scrolling. (From 000 to 250minutes).
6. Set **AREA 2** to **AREA 6** as Step5.

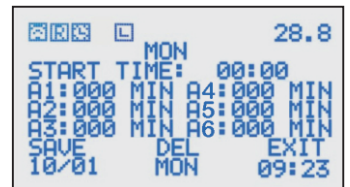

#### Explanation:

- If Set AREA 1 with 000 minute, it means Non-cutting in AREA 1.
- If user doesn't select working in AREA 2. (See **P13-5.12AREA SETTING**). Even user has set a working time in AREA 3, robot will not work in AREA 3.
- 7. Press key or key to scroll to SAVE and save the settings by pressing key .
- 8. Select **DEL** to delete the settings.

### IMPORTANT INFORMATION

By using **SCHEDULE** function, the **LINE** must be turn on or the robot must be put onto virtual wire. Otherwise, the robot don't works under schedule time setting.

### 5.14 LINE

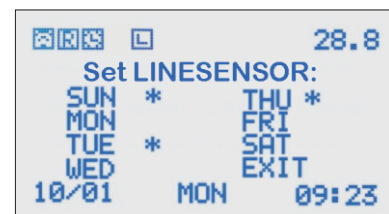

LINE:every time mower starts,it has to find wire cutting and follow it back to station first.

1. Select **AREA** and enter it by pressing key .
2. Select **LINE** and enter it by pressing key .
3. Select which day and confirm the selection by pressing key .

## 6. MAINTENANCE AND STORAGE

### 6. MAINTENANCE AND STORAGE

- During maintenance operations, use the individual protections indicated by the Manufacturer, especially when intervening on the blade.
- Before performing maintenance operations, make sure that the robot has stopped in safety conditions.

PROGRAMMED MAINTENANCE INTERVALS CHART

Frequency	Component	Type of operation	Reference
Every week	Blade	Clean and check the efficiency of the blade	See "Robot cleaning"
		If the blade is bent due to an impact or if it is worn-out, replace it.	See "Blade replacement"
Every month	Robot	Carry out cleaning	See "Robot cleaning"
Every 3 months	Robot	Carry out for recharge	See "Battery"

#### 6.1 Robot cleaning

1. Stop the robot in safety conditions.
2. Wear protective gloves.
3. Clean all the outside surfaces of the robot with a sponge soaked in warm water.
4. Do not use solvents or benzene so not to damage the varnished surfaces and the plastic components.
5. Do not wash the inside parts of the robot and do not use water jets in pressure so not to damage the electric and the electronic components.



#### WARNING

Never use a high-pressure washer or even running water to clean the robot.

6. Check the lower part of the robot (cutting blade area and wheels) and remove the deposits and/or residues that might obstruct the correct functioning of the robot.
7. To remove the deposits and/or other residues from the blade, use a suitable brush.
8. Clean the outside of the charging station from any accumulated residues.
9. Keep all nuts, bolts and screws tight to be sure the appliance is in safe working condition.
10. Replace worn or damaged parts for safety.
11. Ensure that only replacement cutting means of the right type are used.
12. Ensure that batteries are charged by using the correct charger recommended by the manufacturer.
13. Incorrect use may result in electric shock, overheating or leakage of corrosive liquid from the battery.
14. In the event leakage of electrolyte flush with water/neutralising agent, seek medical help if it comes into contact with the eyes etc.

15. Servicing of the mower should be according to manufacturers instructions. This product (include battery pack) must be disposed of at a designated collection point for electrical and electronic waste. For more information, contact your local city office or the shop where you purchased the product.

#### 6.2 Robot Storage

Packed the mower and all spareparts with the original package, and storage the carton off the ground in a cool, dry place. Temperature should not be colder than 14F° (-10°C)

#### 6.3 Blade replacement

Blade model: S520

Blade replace steps:

1. Stop the robot in safety conditions.
2. Wear protective gloves.
3. Turn the Robot upside down.
4. Unscrew the blade and remove it.
5. Replace a new blade and screw it tightly.



#### 6.4 Front wheel cleaning

When front wheels are not easy to rotate, please turn robot upside down, check it and dismantle the screw cap to take out the front wheel out of robot, dismantle end caps and remove the residues, like mud, grass etc from end cap, then reinstall it on the robot.

#### 6.5 Battery

The battery is maintenance-free, but has a limited life span of 1-3years. Battery life is dependent on the length of the using season and how many hours per week the robot is used. A long season or many hours of use per week, means that the battery must be replaced more regularly.

##### - Attentions of lithium batteries

Please charge the lithium batteries in accordance with standard time and procedures.

When the power is too low. It should be started charging as soon as possible.

Storage, we suggest the optimum storage of lithium battery is with 80% power and keep in the shade.

Don't connect the anode and cathode of battery.

Don't take apart, repair or modify the battery privately.

##### - Disused battery processing







Please contact the nearest waste treatment center and consultation with recycling and proper disposal of views.

#### IMPORTANT INFORMATION

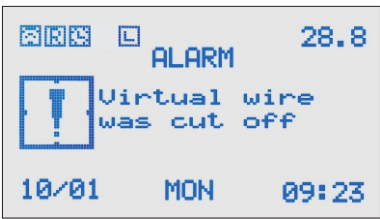
Charge the battery fully at the end of the season before winter storage. And recharge it every 3 months.

## 7.TROUBLE SHOOTING

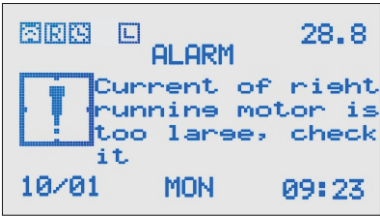
### 7. TROUBLE SHOOTING

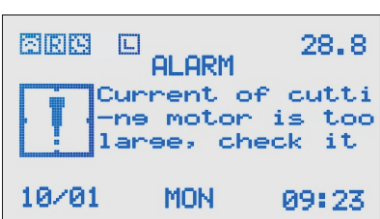
Problem	Display	Possible reasons	Solutions
After enter the correct password and select AUTO mode, but the mower still can not start. And the charging station is beeping.		<ol style="list-style-type: none"> <li>1.The virtual wire fails to send signals.</li> <li>2.The virtual wire was cut off.</li> </ol>	<ol style="list-style-type: none"> <li>1.Check the virtual wire light on charging station. Be sure the virtual wire is connected to the charging station well (light in colorless).</li> <li>2. Connect the virtual wire with wire connectors.</li> </ol>
After enter the correct password and select AUTO mode, but the mower still can not start.		<ol style="list-style-type: none"> <li>1. No power to plug receptacle or main power is shut off. Bad communication between charging station and mower.</li> </ol>	<ol style="list-style-type: none"> <li>1. Check the power and make sure the charger is connecting well with power supply and charging station.</li> </ol>
During operating, mower stops cutting enters standby mode and beeping.		<ol style="list-style-type: none"> <li>1. User touch the handle at backside of mower.</li> <li>2. Water or wet grass drop on the handle.</li> </ol>	<ol style="list-style-type: none"> <li>1.Do not touch the handle. Restart the mower.</li> <li>2.Dry the handle and restart the mower.</li> </ol>
Mower stops working and beeping.		<ol style="list-style-type: none"> <li>1. Mower is lifted from ground.</li> <li>2. Someone or object ride or sit on the mower.</li> </ol>	<ol style="list-style-type: none"> <li>1. Take the mower on level ground and restart it.</li> <li>2. Take the object away from mower and restart it.</li> </ol>
Mower stops working and beeping.	 	<ol style="list-style-type: none"> <li>1. Running wheel strike hard objects.</li> <li>2. The mower is trapped in lawn.</li> </ol>	<ol style="list-style-type: none"> <li>1. Clean the lawn and make sure it is free from hard objects.</li> <li>2. Clean the lawn where mower is trapped or restart the mower in another place.</li> </ol>
Mower stops working and beeping.		<ol style="list-style-type: none"> <li>1. Cutting height is too low</li> <li>2. Blade strikes hard objects.</li> <li>3. Mower is trapped in lawn</li> </ol>	<ol style="list-style-type: none"> <li>1. Adjust the cutting height to suitable height.</li> <li>2. Clean the lawn and make sure it is free from hard objects.</li> <li>3. Clean the lawn where mower is trapped or restart the mower in another place.</li> </ol>

## 7.TROUBLE SHOOTING

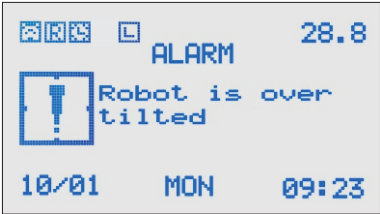
Problem	Display	Possible reasons	Solutions
Mower stops working and beeping.		Mower is tilted over than 30 degrees from the ground.	Turn off the mower and take the mower to level ground. Then restart the mower.
Remote control does not work.		<ol style="list-style-type: none"> <li>1. The battery is low.</li> <li>2. Remote control is not match with robot.</li> </ol>	<ol style="list-style-type: none"> <li>1. Change new batteries.</li> <li>2. Match the frequency with mower.</li> </ol>
The batteries can not recharged		Power nearing natural end of life.	<ol style="list-style-type: none"> <li>1. Send the mower to service station and replace the battery.</li> <li>2. Check whether charger is well connected.</li> </ol>
		<ol style="list-style-type: none"> <li>1. Grass is extremely overgrown or very wet,</li> <li>2. Terrain needs landscaping repairs.</li> </ol>	<ol style="list-style-type: none"> <li>1. Cut the grass appropriate height.</li> <li>2. Fill in all holes, cover or exclude all exposed roots in order to smooth the terrain.</li> </ol>
Mower does not complete the edge.		Obstacle along the path.	Watch the full operation of follow virtual wire walking and confirm no obstacle is present.
Mower does not detect the charging station contacts.		The ground before the charging station isn't flat.	Reset the charging station in a flat place.
Mower reached the charging station when its contacts are above the charging sheets.		Height difference between the charging station and lawn surface at the entrance to charging station	Confirm the ground before the charging station is leveled with the station if necessary fill area with dirt and level off.
The mower behaves in an anomalous around flower beds.		Virtual wire incorrectly placed	Relocate the virtual wire.
The mower is very noise.		<ol style="list-style-type: none"> <li>1. Damaged cutting blade.</li> <li>2. Cutting blade flooded by residues(tapes, ropes, plastic fragments, etc)</li> <li>3.The start of mower occurred with obstacles being too closed (less than 1m away) or in presence of unexpected obstacles (fallen branches, forgotten objects, etc.)</li> <li>4. Damaged running motor or cutting motor.</li> <li>5. Grass too high.</li> </ol>	<ol style="list-style-type: none"> <li>1. Replace a new blade.</li> <li>2. Stop the mower in safety, use protection gloves to avoid the risk of cuts on hands, remove the fold cause from blade.</li> <li>3. Start the robot in new place.</li> <li>4. Get the motor repair or replace by service station.</li> <li>5. Increase the cutting height or use a normal lawn mower.</li> </ol>

# 8. EXPLODED VIEW

Robot Exploded View

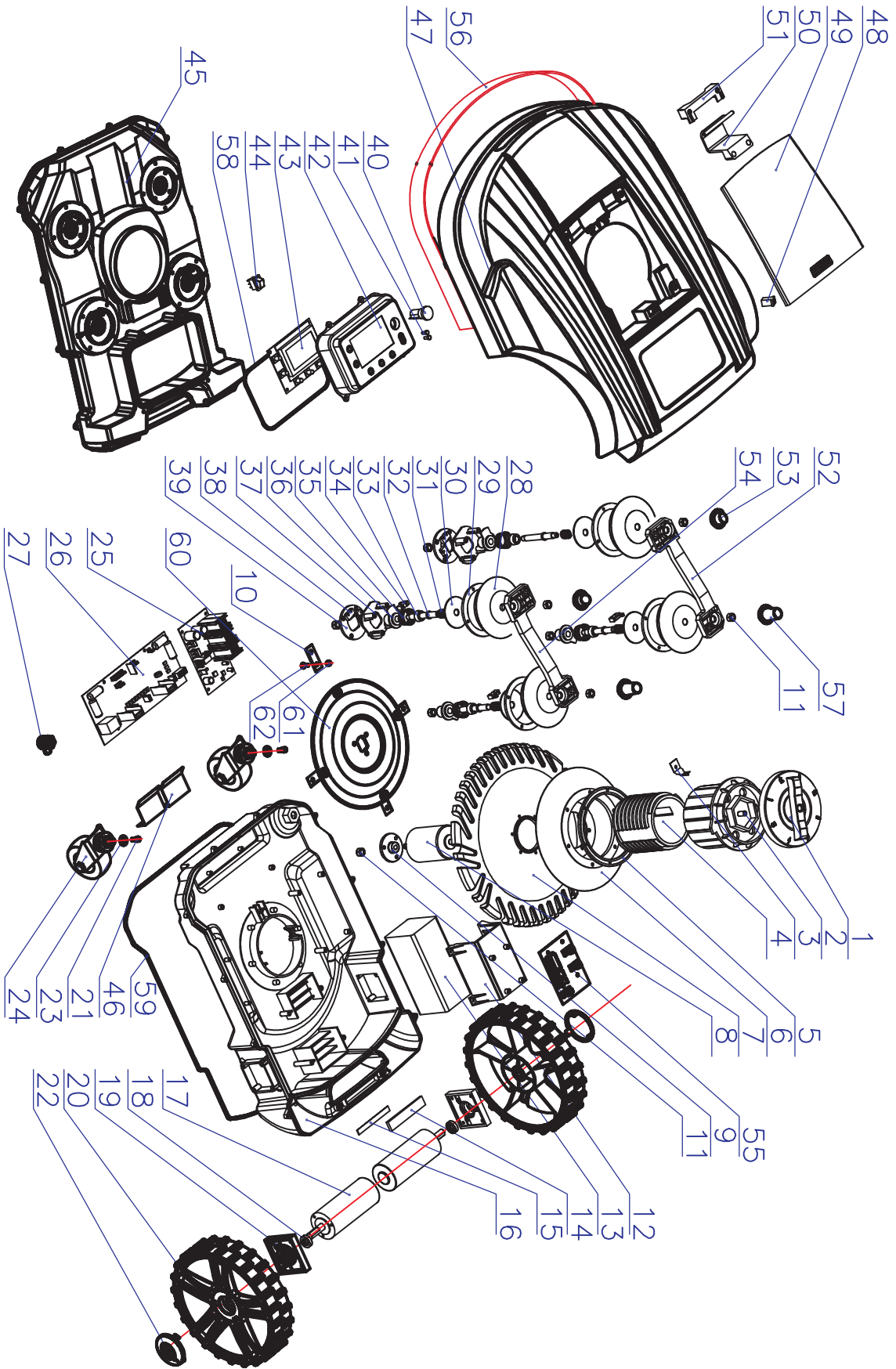

## 8. EXPLODED VIEW

### Robot spareparts list:

No.	Sparepart Name	No.	Spareparts Name	No.	Spareparts Name
1	Rotating knob	24	Front wheel	47	Top cover
2	Cutting motor fixing seat	25	Brushless motor PCB	48	Clip
3	Spring lock	26	Main PCB	49	Clamshell
4	Cutting motor base	27	USB connector	50	Axle for clamshell
5	Rubber ring	28	Rocking bar rubber	51	Clamshell fixed block
6	Gasket for rubber ring	29	Pressure ring for rubber	52	Connecting rod-right
7	Protective shield	30	Gravity pressure ring	53	Rubber hat (front)
8	Cutting motor	31	Gravity spring	54	Connecting rod-left
9	Blade head	32	Axle for rocking bar	55	Connecting PCB
10	Blade	33	Support ring	56	Bump rubber
11	M8 screw cap	34	Micro switch	57	Rubber hat (back)
12	Battery cover	35	Reposition spring	58	Seal ring for display
13	Battery	36	Centering block	59	Seal strip
14	Touch PCB fixed block	37	Permanent seat	60	Blade shield
15	Touch sensor PCB	38	Micro switch	61	M5 screw cap
16	Bottom base	39	Micro switch block	62	M5 screw (for blade)
17	Running motor	40	Emergency switch		
18	Oil seal	41	Rain sensor		
19	Running motor end cap	42	Display cover		
20	Rear wheel	43	Display PCB		
21	Screw for front wheel	44	Power button		
22	Wheel shell	45	Middle cover		
23	Gasket for front wheel	46	Recharging sheet		

### Charging Station Exploded View

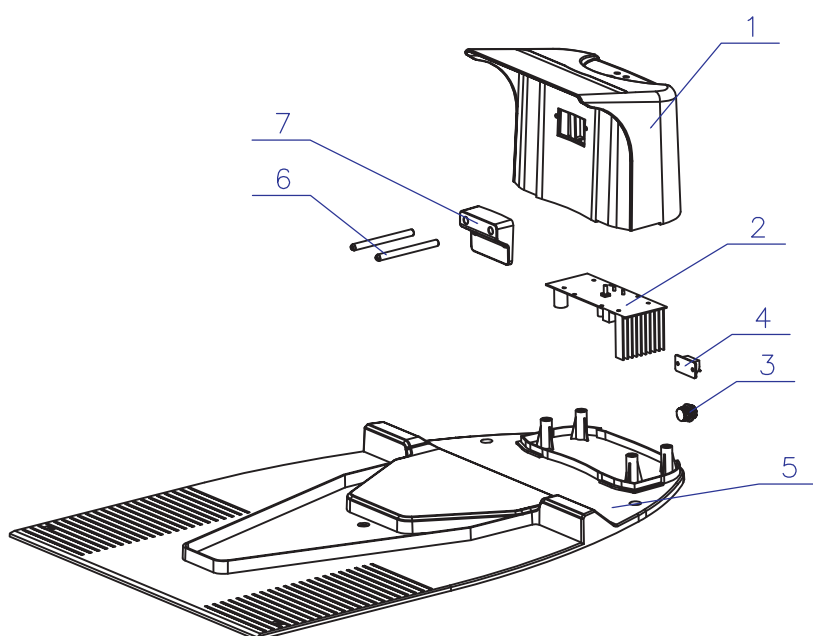

- 1.Top cover
- 2.PCB
- 3.Power terminal
- 4.Virtual wire terminal
- 5.Underpan
- 6.Copper head
- 7.Copper sheet permanent seat



# **Robot** lawn mower

---

USER MANUAL